

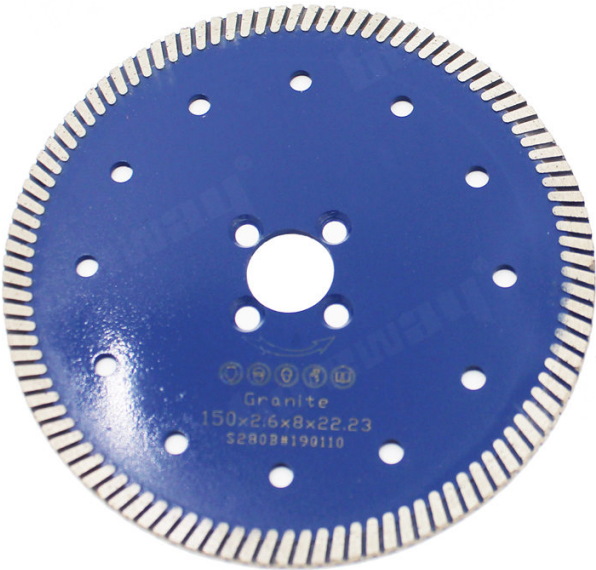

boreway[®]



Boreway 230mm [Placeholder]

230mm [Placeholder]

- 1. [Placeholder]
- 2. [Placeholder]
- 3. [Placeholder]
- 4. 230mm [Placeholder]



230mm [Placeholder]

- 1. [Placeholder]
- 2. [Placeholder]
- 3. [Placeholder]

Our factory use original high grade diamond



Other factory mix second diamond selected from waste segment



pk

Our blade cutting effect



Other supplier blade cutting effect

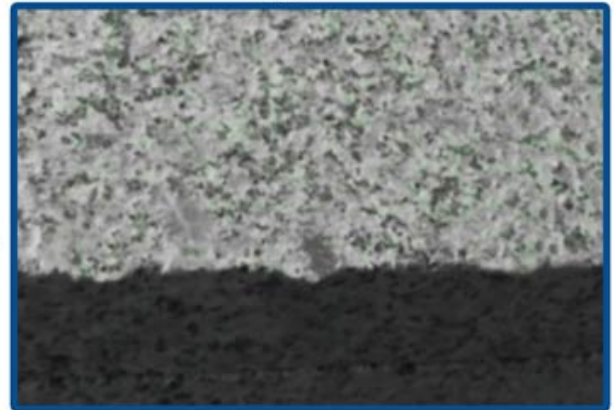

pk



□□□□□□ 230□□□□□□□□





□□□□□□□□□□□□□□□□□□



230mm□□□□

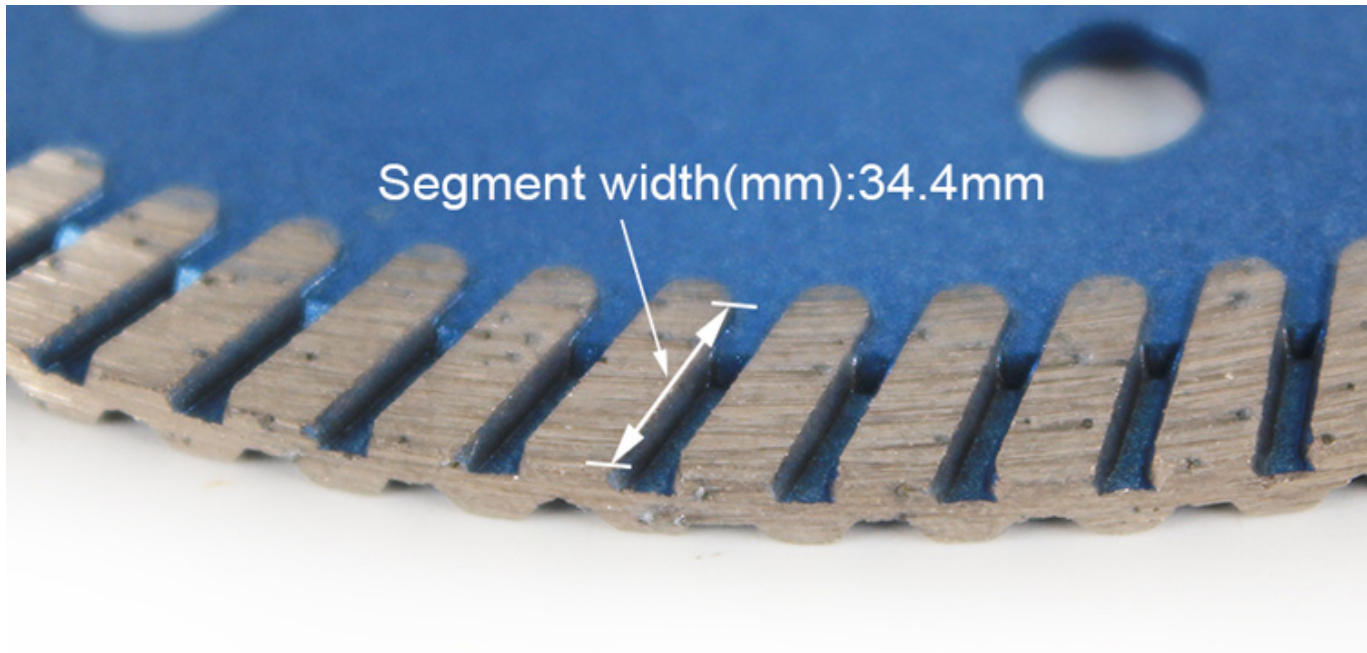



Segment Thickness(mm)

Narrow Tooth Continuous Turbo Rim

150
S

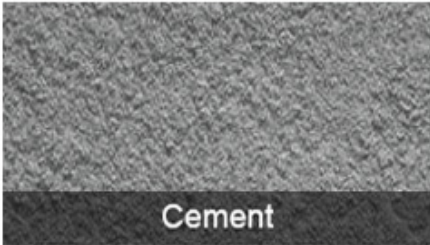

Cement

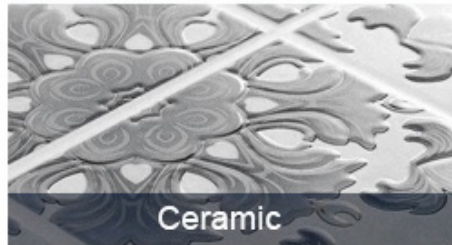

Ceramic

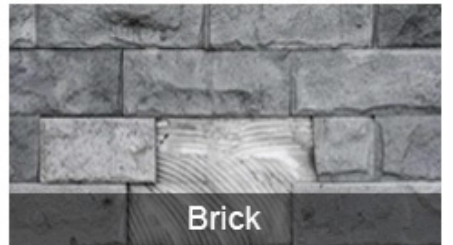

Brick



Concrete



Stone



Granite



□□□□□□□□

230mm□□□□ □□ □□ □□□□□□□□□□□□



Electric circular saw



Angle Grinder



Road cutting machine



Multi-function cutting machine

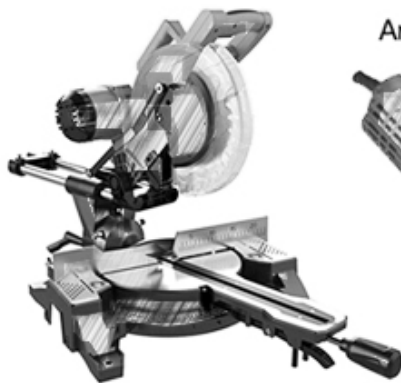

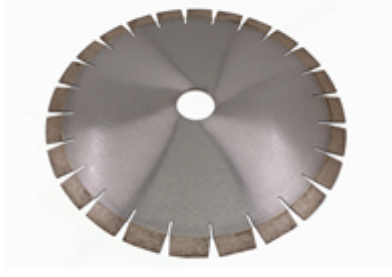

Boreway Machinery Co., Ltd.
www.diamondtools.top
www.boreway.com

D350 * 3.2 * 20 * 40mm * 50 / 60mm



Boreway Machinery Co., Ltd.
www.fordiamondtools.com
www.diamondtools.top

350

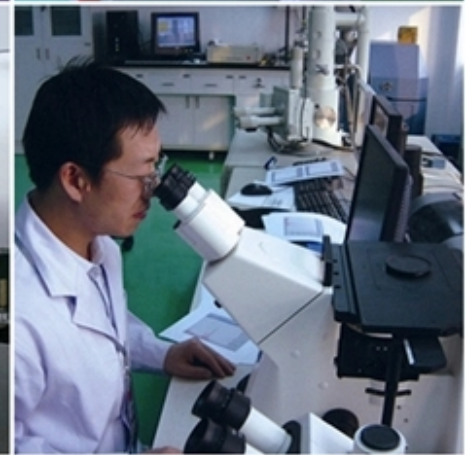



□□□□□□

PS□

1.□□□□□

2.□□□/□□□□□□□□□□□□□□/□□

3.□□45kg□□□□□□□□□□□

4.□□□□□□□□□□□□□□

XX

XXXXXX

Fujian Nanan *boreway*[®] Machinery Co.,Ltd.

 XXXXXXXXXXXXXXXXXXXX605X362342

 XXXX +86X595-86990206 /  XXXX +86X595-86990220

 XXX/ **WhatsApp** /XXXX + 86X 18650679939

 XXXXXX **boreway@boreway.com**

 XXXX