



**Our factory** use original high grade diamond



**Other factory** mix second diamond selected from waste segment



pk

**Our blade** cutting effect



**Other supplier** blade cutting effect

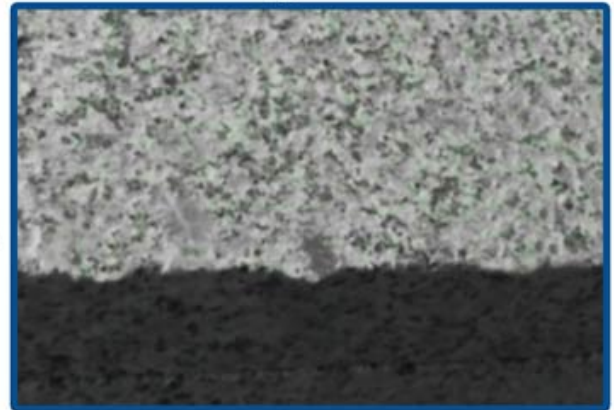

pk

□□:

□□□ □□□□ □□□□ **230mm** □ □□□ □□ □ □□□ :

†

00 000 00 00 000 000 000 00 00 000 000 00 0000.

00 00:

**230mm** 0 000 00 0 000

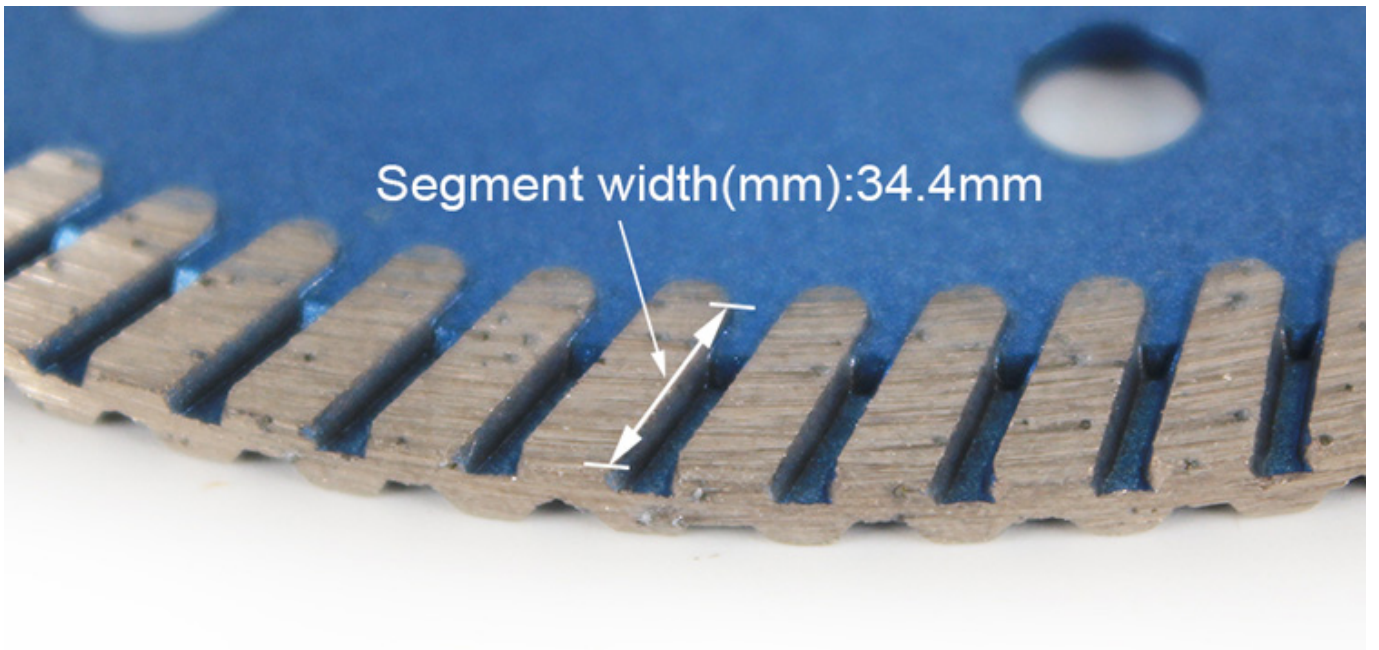



Segment Thickness(mm)

Narrow Tooth Continuous Turbo Rim

150  
S



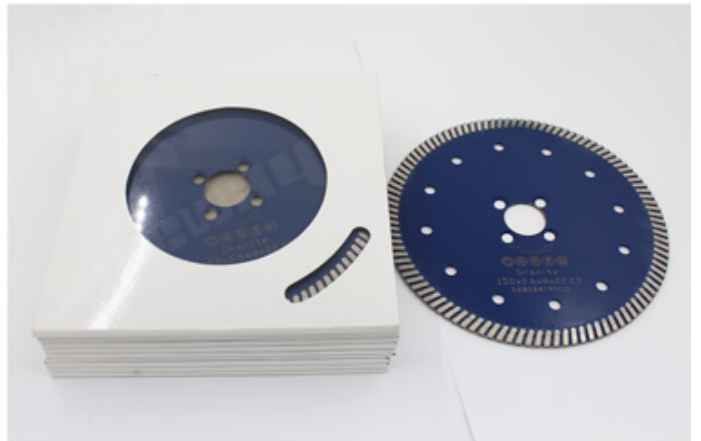
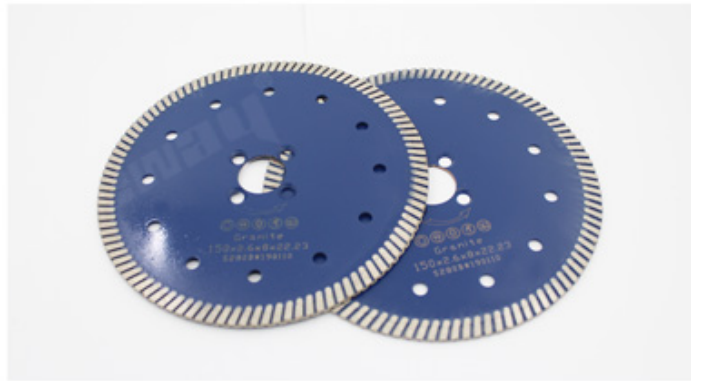
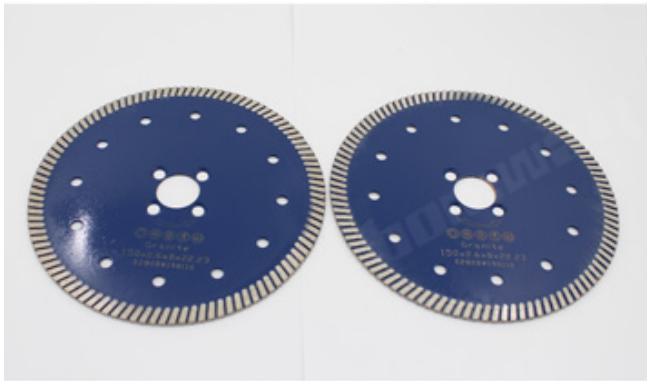

□□□□ □□ :

1. □□□ □□□□ □□ □□□ □□□ □□ □ □□ □□□□□□□□.  
 □□□ □□□ □ □□□ □□□ □□□□ □□□□□□□□□□  
 □□ □□□ □□□□ □□ □□□ □□ □ □□□□ □□□□□□□□.
2. □□□ □□ □□ □ □□□ □□□□ □□□□.
3. □□□ □□□□ □□ □□, □□ □□ □ □□□, □□ □□□ □□□□□□□□, □□□ □□ □□□□ □□□, □□□ □□ □□□□□□□□.
4. □□ □□□□ □□ □□□ □□□□□□□□.

□□ :

**230mm** □ □□□ □□ □ □□□ □□□□, □, □□□□, □□, □□□□, □□□□ □□ □ □□ □□□ □□□□□□.

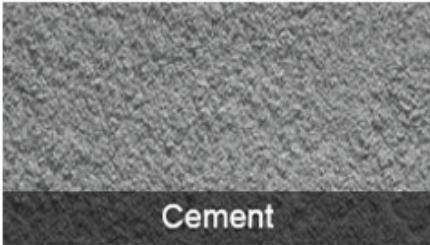

Cement

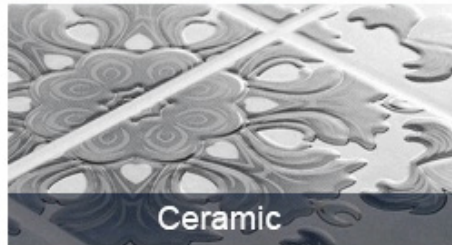

Ceramic

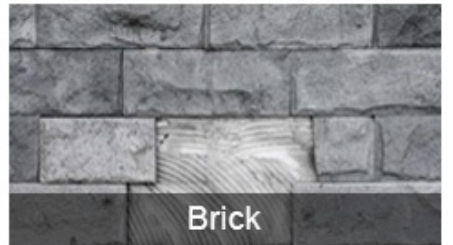

Brick



Concrete



Stone



Granite

□□ □□□□ □□ :

□□ □□, □□ □□ □□ □□!

**230mm** □ □□□ □□ □ □□□ □□□□ ...□ □□ □□ □□□□, □□ □, □□ □, □□□ □



Electric circular saw



Angle Grinder



Road cutting machine



Multi-function cutting machine

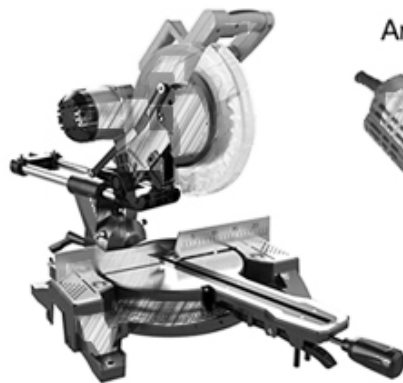

□□ □□:



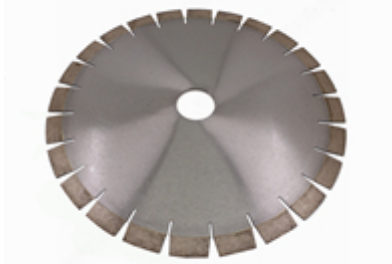

Boreway Machinery Co., Ltd.  
www.diamondtools.top  
www.boreway.com

D350 \* 3.2 \* 20 \* 40mm \* 50 / 60mm Slit Cutting Saw



Boreway Machinery Co., Ltd.  
www.fordiamondtools.com  
www.diamondtools.top

350mm □□□□ □□□□ □□ □□□□ □□

□□ □□ :





□□ □ □ □ :

□□:

1. □□ □□ □□ □□

□□ □□□□ 2.By □□ / □□, □□ / □□ □□

3. 45 □□□□, □□□□ □□ □□□□ (□)

4. □□□ □□ □ □□ □□□□ □□□□□.





□□□ □□□:

1. □□ □□ □□ : □□□ □□□ □□□ □□.
2. □□ □□ :□□ □□□□□□□ □ □□ □□□□□□□.
3. OEM □□ : □□□ □□ □□ □□□ □□ □□ □ □ □□□□.
4. □□ □□ : □□□ □□□ □□ □□ □□□□ □□□□. □□□□ □□ □□□ □□ □□□□.
5. □□ □□□ : □□□ □□ □□□ □□□□ □□□ □□ □□□ □□□□□ □□□□□.

□□□□ □□:

1. □□□ □□□ □□□ □□□□ □□ □□□, □□□ □□□ □□□ □□ □□□□?  
 □□ □□□□ □□□□□ □□□ □ □ □□□□. □□□□, □□□□ □□ □□□□□ □□□□ □□ □□ □□□□ □□ □□ □□□ □□□□□. □□□□ 8 □ □□□ □□ □□□ □□ □□ □□□□□ □□ □□□□□□□.
2. □□□ □□ □□□ □□?  
 □□□ □□ □□□ □□□□ □□□□. □□□□ □□□ □□□□ □□□ □□□ □□□ □□ □□□ □□ □□□ □□□□ □□□□. □□□ □□□□□□ □□□ □ □□ □□□ □□□ □ □□□□ □ □□□□ □ □□□□. □□□□ □□ □□□□ □□□ □□ □□□ □□ □ □□□□□□□□□. □□□□ □□ □□□ □□□□□□.
3. □□□□ □□□ □□□ □□□□□?  
 □□□, □□□□ □□□ □□□□□□□□. □□ □□□, □□ □□ □□ □□□□ □□□ □□ □□□ □□□□ □□ □□□□ □□□ □□□ □□□ □ □□□□. □□□□ □ □□ □□ □□□ □□□ □□□ □□□□ □□□□ □□□□□. □□□□□ □□□□ □□□ □□□ □□□ □ □□□□. □□□□ □□□ □□□ □□ □ □□□□□ □□□ □□□ □□□ □□ □ □□□□□ □□□ □□ □□□□□ □ □□□□□ □ □□□□.

☎ :

歡迎各界人士垂詢。本公司備有各種型號之機器。價格公道。品質優良。歡迎各界人士垂詢。☎ : (+86) 595-86990206 / 595-86990220

📍:

Fujian Nanan **boreway** Machinery Co.,Ltd.



No.605 Huahui Center, Shuitou Town 362342 Quanzhou, 福建



☎ : (+86) 595-86990206 /



☎ : (+86) 595-86990220



☎ / **WhatsApp** / **Wechat** : (+ 86) 18650679939



☎: **boreway@boreway.com**



☎